

ALÇADO

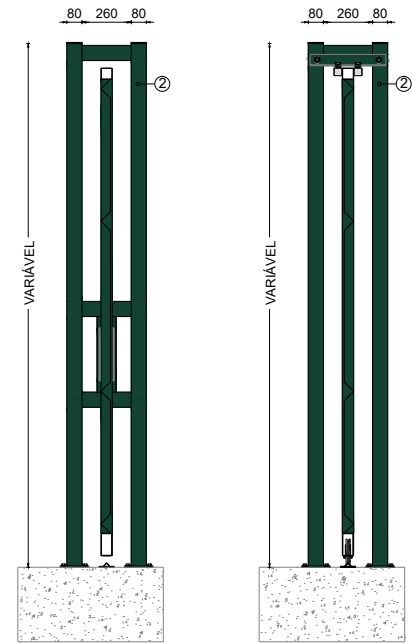

CORTE A

CORTE B

DIMENSÕES:

Altura	Comprimento	Tubo 1	Tubo 2	Tubo 3
2640 mm	3000 mm	60x60x2mm	80x80x2mm	120x60x2mm
	4000 mm	60x60x2mm	80x80x2mm	120x60x2mm
	5000 mm	60x60x2mm	80x80x2mm	120x60x2mm
	6000 mm	60x60x2mm	80x80x2mm	120x60x2mm
	7000 mm	60x60x2mm	80x80x2mm	120x60x2mm
	8000 mm	80x60x2mm	100x100x2mm	160x80x3mm
	9000 mm	80x60x2mm	100x100x2mm	160x80x3mm
	10000 mm	80x60x2mm	100x100x2mm	160x80x3mm
	11000 mm	80x60x2mm	100x100x2mm	160x80x3mm
12000 mm	80x60x2mm	100x100x2mm	160x80x3mm	

CORES:

-  Verde RAL 6005
-  Branco RAL 9010
-  Preto RAL 9005
-  Cinza RAL 7040
-  Azul RAL 5010

*Outras cores disponíveis por encomenda



Portões fabricados na Vedamisto em Aveiras com um design atractivo e funcional. Galvanizados, tanto no interior como no exterior e, plastificados por aplicação electrostática de poliéster. Todos os portões incluem uma ampla gama de acessórios, tais como, fechaduras, batentes, puxadores, dobradiças reguláveis, ferrolhos de solo, acessórios para segurança e controlo de acesso (motorização).

Perfis fabricados a partir de chapa galvanizada, a quente com uma cobertura interior e exterior de zinco média de 275 g/m². Plastificados por aplicação electrostática de poliéster (min. 120 microns).

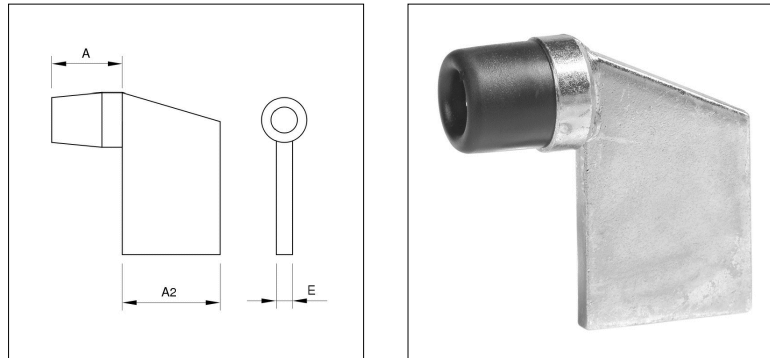

Acessórios Sá Castro

Batente de chumbar ref. 420x

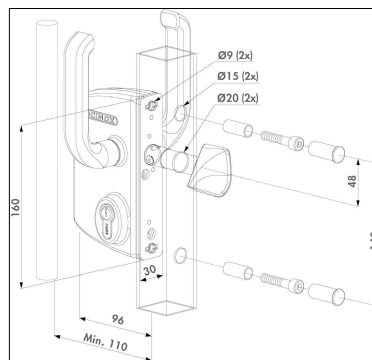
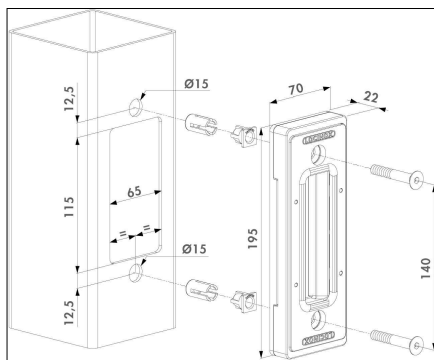

Acessórios Locinox

Fechadura ref. LSKZU2 + SSKZQF + O-SET



PME líder 20

Certifica-se que a empresa **Vedamisto, Lda.** foi distinguida pelo IAPMEI, pela qualidade do seu desempenho e perfil de risco, como **PME Líder 2020**.

25 de Novembro de 2020



Presidente do Conselho Diretivo do IAPMEI
Nuno Mangas



CONTACTOS ZONA CENTRO

Aveiras de Cima
Estrada Nacional 366 Km 21.10 Sítio dos Poços
2050-145 Azambuja

+351 263 098 137 | +351 912 896 589
geral@vedamisto.pt

CONTACTOS ZONA SUL

Guia -Albufeira Estr. Nacional 125 , Km 65 Sítio da Arrancada
8200 – 413 Guia-Albufeira

+351 289 562 002 | +351 913 000 277
geral@vedamisto.pt