

DETAIL A
SCALE 1 : 10

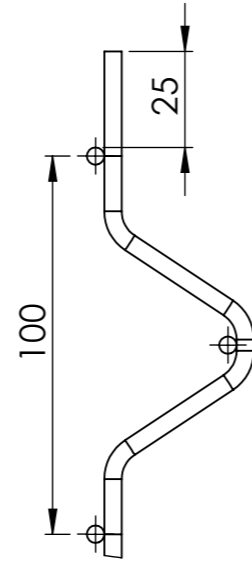

DETAIL B
SCALE 1 : 2

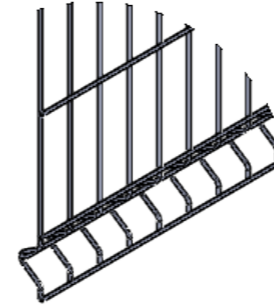

DETAIL C
SCALE 1 : 10

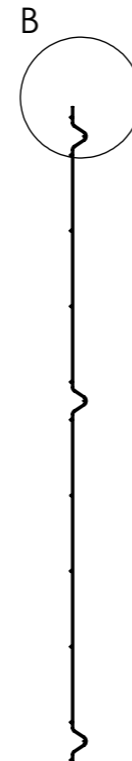
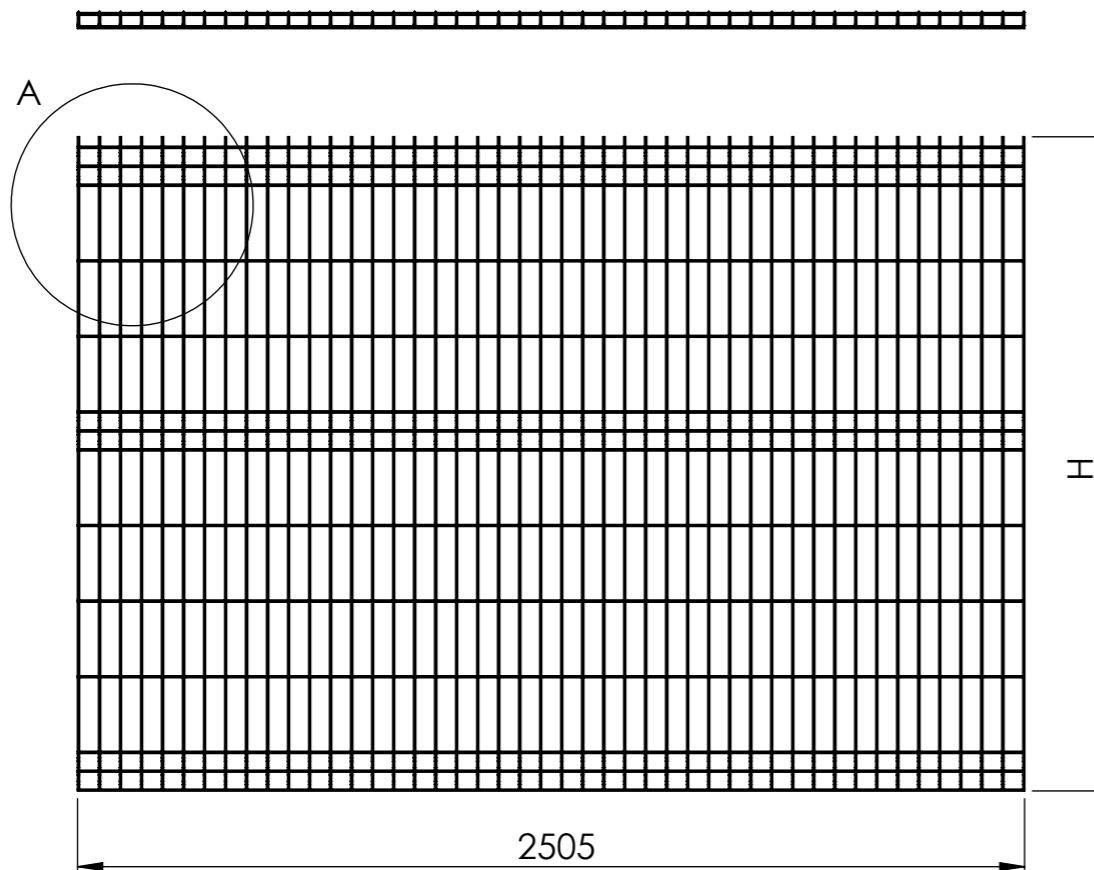
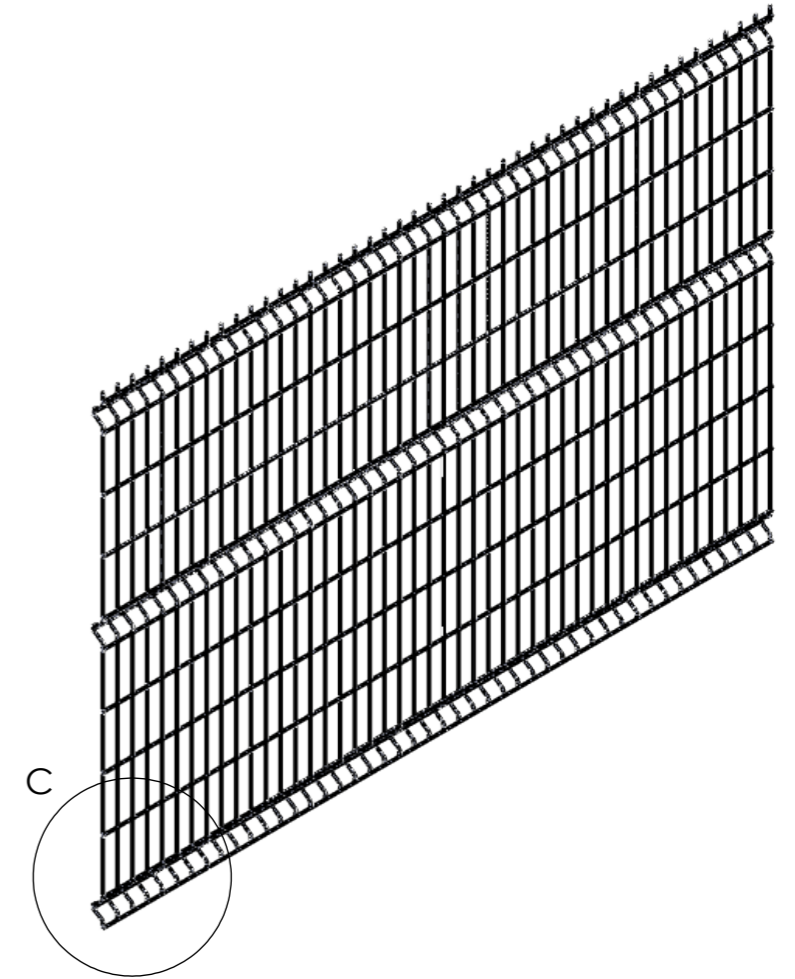

Name	Height (H)	vert. wires	hor. wires
3D 5-5 M55x200 L2500 H0830	0830	46	8
3D 5-5 M55x200 L2500 H1030	1030	46	9
3D 5-5 M55x200 L2500 H1230	1230	46	10
3D 5-5 M55x200 L2500 H1530	1530	46	13
3D 5-5 M55x200 L2500 H1730	1730	46	14
3D 5-5 M55x200 L2500 H1930	1930	46	15
3D 5-5 M55x200 L2500 H2030	2030	46	17
3D 5-5 M55x200 L2500 H2030	2230	46	18
3D 5-5 M55x200 L2500 H2430	2430	46	19
3D 5-5 M55x200 L2500 H2730 (A)	2730	46	23
3D 5-5 M55x200 L2500 H2730 (B)	2730	46	23



Bedrijvenpark Twente 237
7602 KJ Almelo

This document is confidential.
All rights reserved.
Van Merksteijn Fences - Netherlands BV.

Drawing name:
(04-03) Sales
3D ø5-5
M55x200 L2500

Tolerances acc. technical datasheet

REV. 6	Sheet 1
Date: 07-12-2016	Sheets 1
Form. A3	
AvdW	

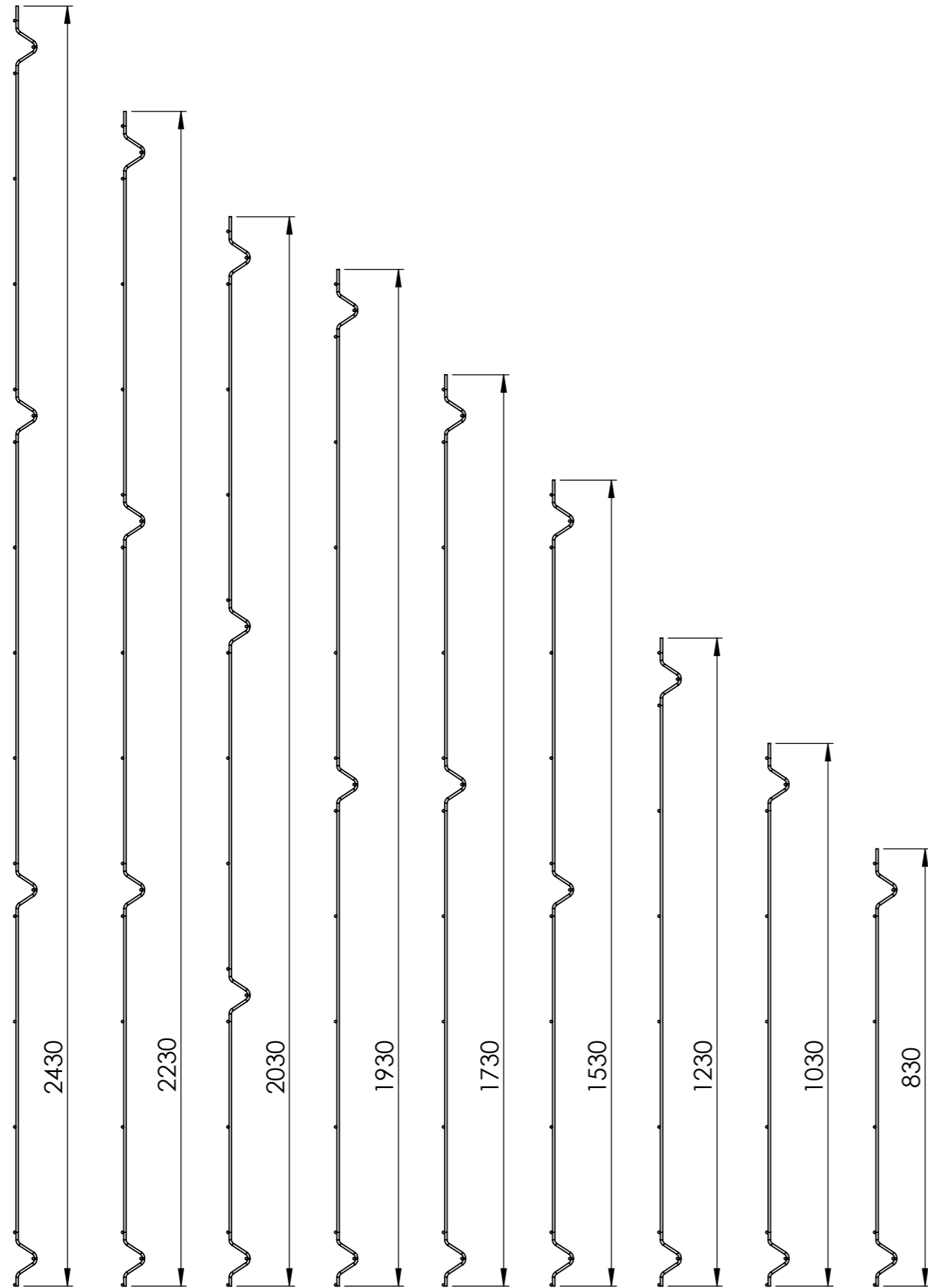
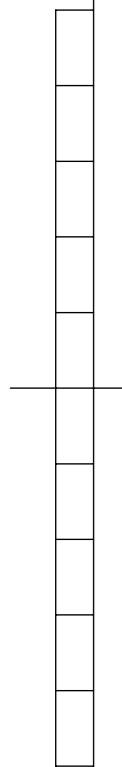

VAN MERKSTEIJN
FENCES
Bedrijvenpark Twente 237
7602 KJ Almelo
This document is confidential.
All rights reserved.
Van Merksteijn Fences - Netherlands BV.

Drawing name:
(04-03) Overview
3D ϕ 5-5
M55x200 L2500

Tolerances acc. technical datasheet

REV. 6	Sheet 1
Date: 07-12-2016	
Form. A3	Sheets 1
AvdW	